

ARIZE™ ELEMENT

L1000

Enabling efficient growth at an industrial scale

With a 232% increase in PPF levels compared to the previous generation, the Arize™ Element L1000 is a true one-to-one high pressure sodium lamp replacement for greenhouse and indoor applications.

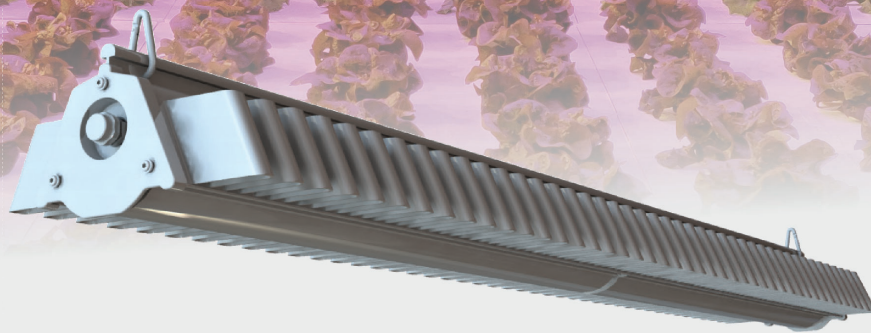

■ **Efficient**

Energy efficiency surpassing $3.5 \mu\text{mol/J}$ makes the L1000 the most efficient grow light in its class

■ **Flexible**

Multiple bracket, wire and cable options mean the L1000 can be installed on virtually any structure in seconds

■ **Powerful**

Produces the same light output as a 1000W HPS fixture using only 40% of the energy

Installation options

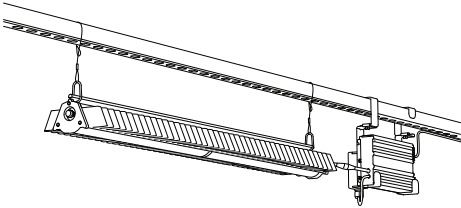

■ Side-by-side

The standard option, with 8" support cables and 1 5/8" square brackets pre-installed on the power supply

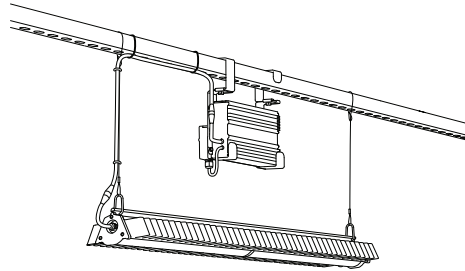

■ Over-under

2', 5' & 10' support cables reduce the distance from the fixture to the crop, for more intense, focused lighting

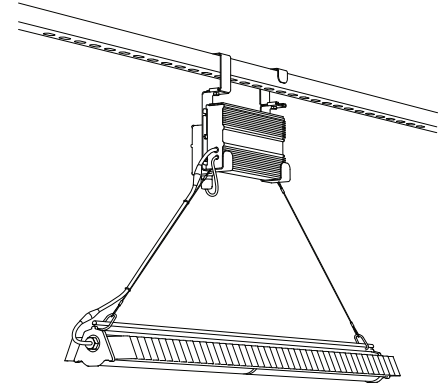

■ Triangular

Pre-drilled holes in the power supply brackets allow the L1000 to be suspended from the power supply



■ Power supply

We offer 2 3/4" and 1 5/8" round and square square brackets, as well as a 12" toggle cable

Mechanical outline

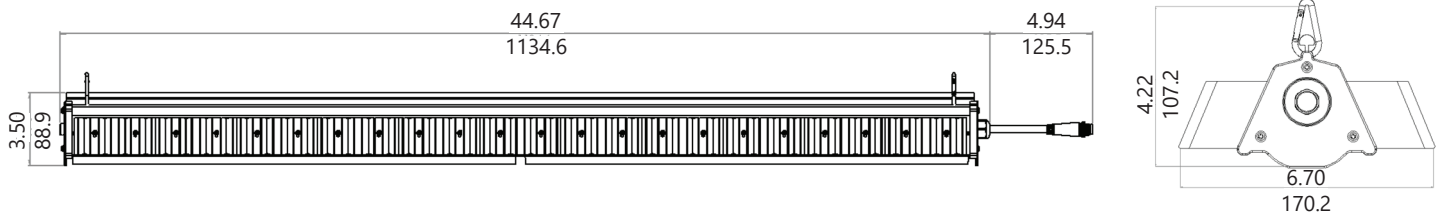

Dimensions and weight

	Length	Width	Height	Weight
L1000 fixture	44.67" 1134.6 mm	6.70" 170.2 mm	3.50" 88.9 mm	7.7 lbs 3.5 kg
Power supply	10.81" 274.5 mm	5.64" 143.26 mm	1.91" 48.5 mm	7.7 lbs 3.5 kg

Spectra

Our purple spectra (PP-) maximize efficiency while providing crops with everything they need, lowering your energy costs while maximizing your output

Our broad spectrum offerings (PK-) are tailored to suit multiple stages of plant growth, from propagation to cultivation, while providing a beautiful environment for work and research

Type R 6:1 (R:B)

Increased electrical and photosynthetic efficiency through increased red light

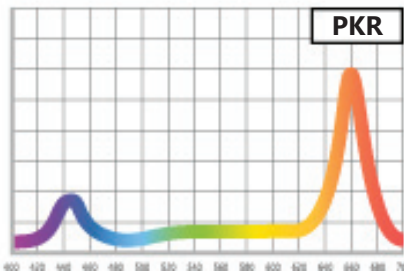
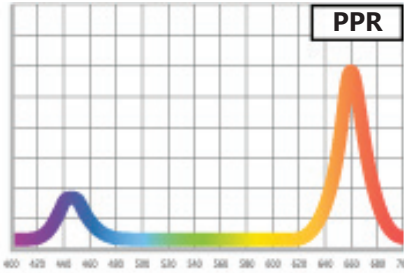

Type B 3:1 (R:B)

Our balanced spectra encourage secondary plant metabolite production

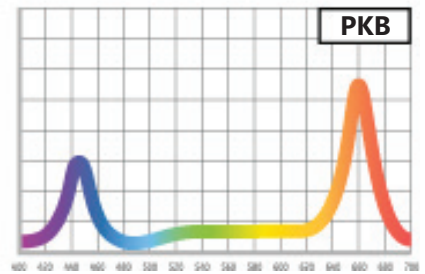
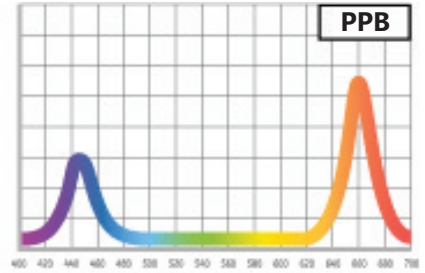

Accessories

Order code	Description	Components
GEHAK-NN-EB-N0	L1000 2' suspension kit	2 ft support cable + 3 ft DC cable
GEHAK-NN-AC-N0	L1000 5' suspension kit	5 ft support cable + 6 ft DC cable
GEHAK-NN-BD-N0	L1000 10' suspension kit	10 ft support cable + 12 ft DC cable
GEHAK-DN-DD-N0	Power supply 2¾" square bracket kit	2¾" square bracket extension + screw + nut
GEHAK-BN-DD-N0	Power supply 2¾" pipe bracket kit	2¾" pipe bracket extension + screw + nut
GEHAK-AN-DD-N0	Power supply 1 3/8" pipe bracket kit	1 3/8" pipe bracket extension + screw + nut
GEHAK-NN-NE-N0	Power supply suspension kit	1 ft loop to toggle support cable
GEHAK-NN-NN-J0	Junction box for dimming	Junction box
GEHAK-NN-NN-N0	Wall-mounted dimming switch	Dimming switch

Order code table

Product ID	Optical code	Input voltage	Distribution	Options	Gen
GEHTL	See optical code table	1 = 120-240V* 2 = 120-277V** 3 = 277-480V**	N = 120°	X = None	1

* Only available with E optical codes

** Only available with M and H optical codes

Optical table

Optical code	Spectrum	PPF*** (μmol/s)	Power (W)	Efficiency*** (μmol/J)	HPS equivalent (W)
EPPR4	R (6:1)	623	178	3.5	400
EPPB4	B (3:1)	612	180	3.4	400
MPPR4	R (6:1)	1038	310	3.3	600
MPPB4	B (3:1)	1013	314	3.2	600
HPPR4	R (6:1)	1827	599	3.1	1000
HPPB4	B (3:1)	1761	601	2.9	1000
HPKR4	R (6:1)	1669	590	2.8	1000
HPKB4	B (3:1)	1631	597	2.7	1000
HPKF4	F (6:1 R:B, 12:1 R:FR)	1531	594	2.6	1000

*** Typical

Specifications

Dimming	0-10V	Operating environment	0°C to 50°C (32°F to 122°F)
Power factor	>0.9	IP rating	IP66
Max. remote mount distance	12 ft (3.6 m)	Lifetime	L90: >36,000 hours
Cooling	Passive	Warranty	Five-year system warranty
Light distribution	120°	System certifications	UL E492907